

# Faecal Sludge and Septage Co-treatment Design Guidebook

**Volume I: Planning and designing**

**Recommendations for co-treatment  
of faecal sludge and septage with sewage  
at Kargi STP Dehradun**

**March 2021**

**Revised edition: April 2022**



National Institute of Urban Affairs



Sanitation Capacity  
Building Platform



# **Faecal Sludge and Septage Co-treatment Design Guidebook**

**Volume I: Planning and designing**

**Recommendations for co-treatment  
of faecal sludge and septage with sewage  
at Kargi STP Dehradun**

**March 2021**

**Revised edition: April 2022**



National Institute of Urban Affairs



Sanitation Capacity  
Building Platform

## TITLE

Faecal Sludge and Septage Co-treatment Design Guidebook - Volume I: Planning and designing recommendations for co-treatment of faecal sludge and septage with sewage at Kargi STP Dehradun

## RESEARCH PROJECT

Sanitation Capacity Building Platform (SCBP), National Institute of Urban Affairs (NIUA), New Delhi

Copyright © NIUA (2021)

Year of Publishing (March) 2021

Revised Edition (April) 2022

## CONTENT

Content for the report is developed by National Institute of Urban Affairs (NIUA), New Delhi

## SENIOR DOMAIN EXPERT AND TEAM LEAD

Depinder Kapur

## PREPARED BY

Shantanu Padhi, NIUA, New Delhi

Sachin Sahani, NIUA, New Delhi

## DISCLAIMER

This is a draft report on “Design Recommendations for Faecal sludge and septage co-treatment infrastructure” at Kargi 68 MLD STP, Dehradun. This is prepared under NIUA-UDD, Govt. of Uttarakhand engagement to support the Uttarakhand state in mainstreaming decentralize sanitation solutions in the state. The study provides design recommendations for Kargi Chowk STP for co treatment, that can be used to prepare DPRs for other STPs in the state as well. The findings of the study ‘Co-Treatment of Septage at STPs of Ganga Towns in Uttarakhand’ done by IIT Roorkee has also been referred during preparation of this document.

While every effort has been made to ensure the correctness of data/information used in this report, NIUA does not accept any legal liability for the accuracy or inferences drawn from the material contained therein or for any consequences arising from the use of this material. No part of this report may be reproduced in any form (electronic or mechanical) without prior permission from or intimation to NIUA.

THE FULL REPORT SHOULD BE REFERENCED AS FOLLOWS

NIUA (2020), Faecal Sludge and Septage Co-Treatment Design Guidebook - Volume I: Planning and designing recommendations for co-treatment of faecal sludge and septage with sewage at Kargi STP Dehradun

Text from this report can be quoted provided the source is acknowledged.

## DESIGN

Designing Team, NIUA

## CONTACT

National Institute of Urban Affairs

1st and 2nd Floor Core 4B, India Habitat Centre,

Lodhi Road, New Delhi 110003, India

Website: [www.niua.org](http://www.niua.org), [scbp.niua.org](http://scbp.niua.org)

# Contents



<b>ABBREVIATIONS</b> .....	<b>3</b>
<b>SALIENT FEATURES</b> .....	<b>4</b>
<b>EXECUTIVE SUMMARY</b> .....	<b>5</b>
<b>1. INTRODUCTION</b> .....	<b>7</b>
1.1 Background .....	7
1.2 City profile .....	7
1.3 Location and connectivity .....	8
1.4 Geography and climate .....	8
<b>2. OVERVIEW OF SANITATION SITUATION- WASTEWATER AND FAECAL SLUDGE AND SEPTAGE MANAGEMENT</b> .....	<b>9</b>
2.1 Excreta flow mapping .....	9
2.1.1 Containment .....	10
2.1.2 Emptying and transportation .....	10
2.1.3 Treatment .....	10
<b>3. DESIGN CONSIDERATIONS</b> .....	<b>12</b>
3.1 Design basis for co-treatment facility .....	12
3.2 Proposed co-treatment units .....	12
3.2.1 Channel design .....	13
3.2.2 Coarse screens .....	13
3.2.3 Fine screens .....	14
3.2.4 Additional requirements for O&M - Sprayer .....	15
3.2.5 Homogenization tank cum stabilization tank .....	15
3.2.6 Pump requirements for homogenisation tank .....	16
3.2.7 Dewatering using centrifuge unit .....	18
3.2.8 Sludge drying beds.....	18
3.3 Process flow diagram for co-treatment.....	23
<b>4. OPERATION AND MAINTENANCE</b> .....	<b>24</b>
4.1 Truck arrival and faecal sludge decanting .....	24
4.2 Screening chamber .....	24
4.3 Tap with sprayer .....	24
4.4 Homogenisation tank.....	25
4.5 Electricity .....	25

<b>5. RE-USE OF BY-PRODUCTS FROM FSS TREATMENT AT KARGI STP .....</b>	<b>26</b>
<b>6. REFERENCES .....</b>	<b>27</b>
<b>7. ANNEXURE .....</b>	<b>28</b>
7.1 Flow diagram of Kargi STP.....	28
7.2 Unit process and operations of STPs with dimensions .....	29
7.3 Summary of study and analysis conducted by IIT Roorkee .....	29
7.4 Minutes of the meeting for co-treatment at Kargi STP .....	31
7.5 Design considerations: To check compatibility for discharging FSS.....	33

## LIST OF FIGURES

<b>Figure 1:</b> Location of Dehradun	8
<b>Figure 2:</b> Shit flow diagram of Dehradun	9
<b>Figure 3:</b> Corresponding percentage of population dependent on different types of sanitation systems	10
<b>Figure 4:</b> Private vacuum tanker discharging FSS into a chamber connected to MPS in Kargi STP	11
<b>Figure 5:</b> Plan and cross section for receiving chamber	14
<b>Figure 6:</b> Plan and cross section of homogenisation tank	17
<b>Figure 7:</b> Plan and cross section of sludge drying beds for dewatered sludge	20
<b>Figure 8:</b> Plan and cross section of sludge drying beds for bottom sludge of homogenisation tank	22
<b>Figure 9:</b> Process flow diagram of co-treatment units	23
<b>Figure 10:</b> Process flow diagram of the STP	28

## LIST OF TABLES

<b>Table 1:</b>	Estimation of wastewater and faecal sludge generation	11
<b>Table 2:</b>	List of STPs and their utilisation in Dehradun	11
<b>Table 3:</b>	Estimation of volume of faecal sludge received at STP	12
<b>Table 4:</b>	Sewage, faecal sludge and septage characteristics	12
<b>Table 5:</b>	Pump calculations	16
<b>Table 6:</b>	Compatibility calculation for FS dewatering at centrifuge unit	18
<b>Table 7:</b>	Calculation for requirement of sludge drying beds	19
<b>Table 8:</b>	Proposed modules and their sizing	23
<b>Table 9:</b>	Units dimensions of STPs	29
<b>Table 10:</b>	Sewage test results by IIT Roorkee	29
<b>Table 11:</b>	Septage characteristics analysed by IIT Roorkee	30
<b>Table 12:</b>	Calculation for septage discharge into STP	30
<b>Table 13:</b>	Compatibility study for co-treatment	33





## ABBREVIATIONS

---

<b>BIS</b>	Bureau of Indian Standard
<b>BOD</b>	Biological Oxygen Demand
<b>CAPEX</b>	Capital Expenditure
<b>COD</b>	Chemical Oxygen Demand
<b>CPCB</b>	Central Pollution Control Board
<b>CPHEEO</b>	Central Public Health & Environmental Engineering Organization
<b>DPR</b>	Detailed Project Report
<b>DWPE</b>	Dewatering Polyelectrolyte
<b>FGD</b>	Focus Group Discussion
<b>FSS</b>	Faecal Sludge and Septage
<b>FSM</b>	Faecal Sludge Management
<b>FSSM</b>	Faecal Sludge and Septage Management
<b>GoI</b>	Government of India
<b>GoUK</b>	Government of Uttarakhand
<b>KII</b>	Key Informant Interview
<b>LPCD</b>	Litres per Capita per Day
<b>MIS</b>	Management Information System
<b>MLD</b>	Million Liters per Day
<b>MoHUA</b>	Ministry of Housing and Urban Affairs (Formerly known as MoUD)
<b>MSL</b>	Mean Sea Level
<b>NFSSMP</b>	National Faecal Sludge and Septage Management Policy
<b>NIC</b>	National Informatics Centre
<b>NIUA</b>	National Institute of Urban Affairs
<b>NMCG</b>	National Mission for Clean Ganga
<b>NUSP</b>	National Urban Sanitation Policy
<b>OD</b>	Open Defecation
<b>OPEX</b>	Operational Expenditure
<b>OSS</b>	Onsite Sanitation System
<b>OU</b>	Open Urination
<b>PPE</b>	Personal Protective Equipment
<b>SBM</b>	Swachh Bharat Mission
<b>SLRM</b>	Solid Liquid Resource Management
<b>TSS</b>	Total Suspended Solids
<b>UDD</b>	Urban Development Department
<b>UK</b>	Uttarakhand
<b>UJS</b>	Uttarakhand Jal Sansthan
<b>UKEPPCB</b>	Uttarakhand Environment Protection and Pollution Control Board

# SALIENT FEATURES

---

Name of the project concept	Co-treatment of FSS with sewage at Kargi STP
City	Dehradun
Project implementation period	3 months
Project cost (tentative)	183.49 lakhs
Schedule of rates	Sewerage items schedule of rates of Jal Nigam (2019)
Areas to be benefited	Dehradun city and suburbs
Population projection	Estimated based on current FS desludge at STP
Design period	Until intermediate design period of STP
Tankers capacity	3 to 5 KL
Current sewage inflow	14 to 20 MLD
Designed capacity of co-treatment facility	130 KLD

# EXECUTIVE SUMMARY

---

Co-treatment is a process where Sewage Treatment Plant (STP), in addition to treating the domestic sewage transported through sewers, also treats faecal sludge and septage (FSS) emptied from various Onsite Sanitation Systems (OSS) in the city.

The need for this facility has arisen to ensure an efficient and appropriate co-treatment of faecal sludge septage (FSS) with sewage, so that the functionality of existing STP is not compromised. Setting up of a dedicated faecal sludge treatment plant (FSTP) is a time-consuming affair due to issues such as land identification, clearances and tendering process. Further, in case of co-treatment, the existing facilities, site infrastructure and human resource of the STP will be used for co-treatment and thus can eliminate the problem of engaging a new O&M operator and additional cost related to site infrastructure.

Co-treatment will provide access to improved sanitation to households, low income settlements, commercial and institutional establishments of the targeted areas where sewer connections are not feasible or it may take some time to provide the designed service. Thus, the co-treatment method will restrict the indiscriminate discharge of highly contaminated faecal sludge into rivers and surrounding environment of the city.

Co-existence of sewerage system with FSSM or until the city is fully covered with sewerage system, in both ways, FSSM through co-treatment is a viable solution. Excreta Flow Diagram (SFT) of the Dehradun attributes to 66% of the population dependent on onsite sanitation systems. However, 130 KLD of FSS is being currently collected in the city but it is estimated that around 350 KLD of FSS is generated (by Production method). Although, sewerage systems are planned for the city, with the growing population in consideration, management of FSS of the city will remain in pursuit of the ULB and parastatal bodies.

- The proposed facility is designed based on the current collection i.e. 130 KLD of FSS which is presently being disposed at Kargi STP without preliminary treatment.
- The state of Uttarakhand is prioritizing FSSM through co-treatment method, and this is evident in its Septage Management Protocol 2017 where co-treatment method is included for FSS treatment.
- Households and establishments which are under city's sewerage plan and yet to to be connected with sewer and or are left out from the plan are thus considered for FSS estimation.
- Land available (currently not in any use) in the STP premise will be used for erecting co-treatment facility

The guidebook is divided into two volumes. Volume 1 of the document details the rationale for co-treatment at kargi STP and the design calculations including pre-feasibility for the proposed co-treatment facility. Volume 2 of the document details the implementation of the facility. A decision making flow chart, template of Terms of Reference (TOR) for design engineers, protocol for trial runs, and a sample bidding document for procurement of works will help the engineers of Pey jal Sansthan and Peyjal nigam to carry-out co-treatment conveniently.



# INTRODUCTION

---

## 1.1 Background

Kargi Sewage Treatment Plant (STP) which was commissioned in the year 2013 with 68 MLD of designed capacity is one of the highest capacity STPs of Dehradun city. The plant is currently receiving 14 to 20 MLD of sewage and more than 100 KLD of FSS. Following the guidance from the ‘Septage Protocol, 2017’ the plant allowed for disposal of FSS at STP in the year 2018. However, due to receiving faecal sludge at STP, the plant operator observed few operational issues like odor, FOG and solids escaping during decanting process of reactor. The reasons for such issues are due to considerably higher solids, organic and nutrient load of FSS ranging from 12,000 to 52,500 mg TSS/L present in FSS as compared to sewage which are typically containing 250 to 600 mg TSS/L. Further, the high strength of FSS have a large impact on the organic, suspended solids and nitrogen loads on the STP and thus impacting its treatment efficiency. The intermittent nature of FSS loading gives rise to high instantaneous loads and thus amplify the problems at STP.

To mitigate the issues and to keep up-running the plant, Uttarakhand Jal Sansthan (UKJS), South Division, Dehradun decided to implement a pilot-scale Co-treatment of Faecal Sludge and Septage at existing Sewage Treatment Plant (STP). With regard to these issues and problems, UKJS requested for technical support from National Institute of Urban Affairs, Delhi (NIUA) to carry out a prefeasibility study and provide design recommendations for co-treatment, see annexure 6.4, Minutes of meeting for co-treatment at Kargi STP.

To assess the feasibility of co-treatment in an STP, the following points are studied:

- The spare capacity in the STP to treat the additional load from FSS
- Study the treatment process of the STP and identify the limiting factors, which can affect treatment
- Existing treatment efficiency of the STP
- Land availability for construction of co-treatment modules

## 1.2 City profile

Dehradun is the capital of the Indian state of Uttarakhand, near the Himalayan foothills. Dehradun is the administrative headquarters of Dehradun district. The city is governed by Municipal Corporation which comes under Dehradun Metropolitan Region, Uttarakhand. As per Census India, population of Dehradun in 2011 was 569,578, which has increased to **8,04,379, after expansion of city boundaries**. There are 1,67,577 households within municipal boundary; this suggests the average household size in the city to be 4.8. In the year 2018, there was delimitation of boundary and total number of wards increased from 60 to 100. The geographical area of the city is 100 km square.

Figure 1: Location of Dehradun



Source: Prepared by NIUA

### 1.3 Location and connectivity

Dehradun lies at 30.3164° N, 78.0321° E. It is part of the Garhwal region and lies along NH7 with the distance of 236 kilometres north of India's capital New Delhi, 168 kilometers from Chandigarh and is served by Dehradun railway station and Jolly Grant Airport, Doiwala. It is one of the counter magnets of the National Capital Region Delhi which is being developed as an alternative centre of growth to help ease the migration and population explosion and also establish a smart city.

It is well connected and in proximity to Himalayan tourist destinations such as Mussorie, Auli and the Hindu holy cities of Haridwar and Rishikesh; along with the Himalayan pilgrimage circuit of Chota Char Dham.

### 1.4 Geography and climate

The city of Dehradun mainly lies in Doon Valley. Doon Valley has the Himalayas to its north, the Shivalik range to its south, the sacred river Ganga to its east and the river Yamuna to its west. The city of Dehradun is surrounded by river Song on the east, river Tons on the west, Himalaya ranges on the north and Sal forests in the south. Dehradun is surrounded by dense forest all around and number of streams and canals dissect the city in the north-south direction. It lies 674m above mean sea level.

The average annual temperature in the city is 21.8°C, June being the warmest month has an average temperature of 29.4°C and with an average temperature of 12.6°C January is the coldest month. Dehradun receives an average rainfall of around 1896 mm per year, the driest month is April with 16 mm of precipitation and with an average of 567 mm, August receives the highest rainfall in the city.

**Soil** here is moderately deep, well-drained, thermic coarse loamy soils, strong, stoniness, associated with shallow excessively drained, loamy skeletal soil. The soil is also associated with excessively drained soils with loamy surface and slight to moderate erosion

# OVERVIEW OF SANITATION SITUATION-

## Wastewater and Faecal Sludge and Septage Management

The state government notified FSSM Protocol for Septage Management G.O. No. 597/IV (2) UD2017-50 (Sa)/16 dated 22nd May 2017. The objective of the protocol was to streamline FSSM operations in the State. The protocol was developed by Urban Development Directorate (UDD) Uttarakhand. As per the protocol, all cities shall constitute Septage Management Committee (SMC) for implementation of septage management activities. Currently, in Dehradun the SMC has been formed. Gray water in most households of the city is disposed into open drains which further gets conveyed through nullahs and disposed into river and streams.

### 2.1 Excreta flow mapping

To understand and map the excreta management of the city along the sanitation service chain, an Intermediate level Shit Flow Diagram (SFD-Popularly known as Excreta Flow Diagram) is prepared.

Figure 2: Shit flow diagram of Dehradun

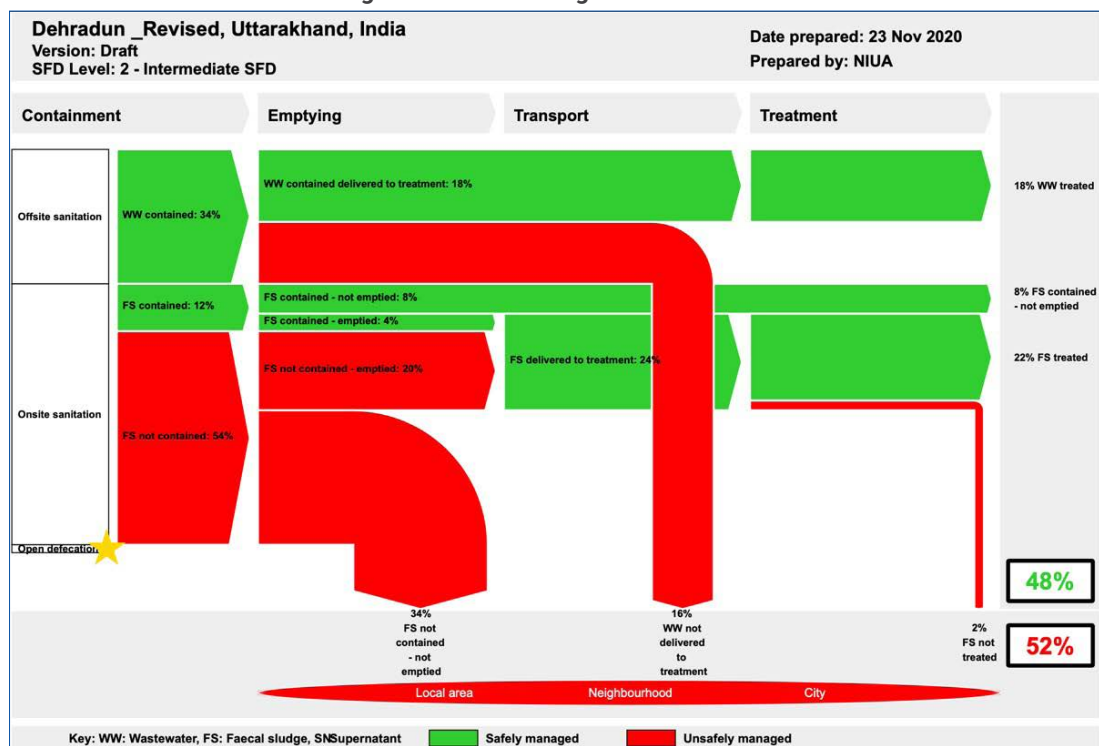

Source: [sfd.susana.org](http://sfd.susana.org)

The service outcomes of the sanitation service chain are analyzed below: -

### 2.1.1 Containment

There are 1,67,577 households, 100% of these households have access to Individual Household toilets. There are 128 notified slums in the city. Additionally, there are 31 public and community toilets. Dehradun has 6 sewerage zones, namely, Kargi, Rispana, Indra nagar, Vijay colony, Salawala and Doon vihar. Currently, these zones are partially served with sewerage network covering 57,173 households which is 34% of the total households in the city. Two more STPs at Banjarawala and Raipur are proposed and expected to be implemented by next 3-4 years. Remaining, 66% i.e. 1,10,404 households have onsite containment systems. Open defecation is not practiced in the city.

Through key informant interviews (KII) and focus group discussions (FGDs) with municipal officials, masons, emptiers; households dependent on different types of sanitation systems are estimated:-

Figure 3: Corresponding percentage of population dependent on different types of sanitation systems

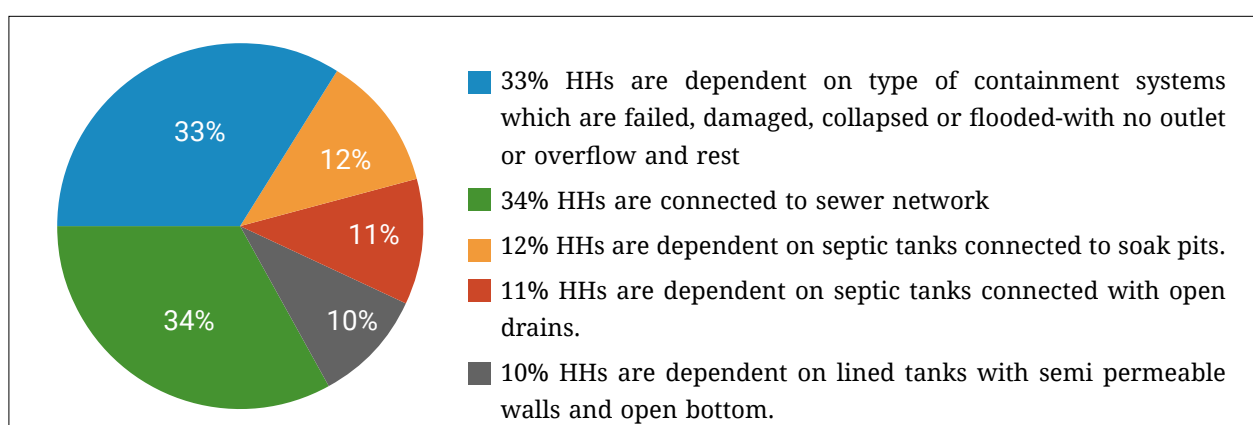

Source: SFD of Dehradun

### 2.1.2 Emptying and transportation

Predominant method of emptying is by cess pool operators which is carried out by private player as there is no registered cesspool operator available in the city. There are around 25 cesspool vehicles in the city, owned by private players. Currently, the emptiers do 30 trips per day during weekdays and around 40 trips in weekends. The capacity of tankers ranges from 3.5 to 5.0 KL. Based on above data, it is roughly estimated by 'collection method' that 130 KLD of FSS is generated. The average desludging frequency of the containments is 5-8 years.

The emptying charge is approximately Rs.1500-2200 per service depending on the distance of the household from the STP. A tipping fee of Rs.400 is charged by Kargi STP from the desludging operators.

### 2.1.3 Treatment

It is attributed that 48% of the WW and FSS is safely managed in the city and the rest 52% is unsafely managed by indiscriminately discharging at neighborhood. The volume of wastewater and faecal sludge generated in the city is estimated based on following assumptions:



Table 1: Estimation of wastewater and faecal sludge generation

Type of Waste	Population (including 10% floating population)	Per capita per day generation (Year -2020)	Volume generation
Waste water	884816	135 lpcd X 80%	~95 MLD
Faecal sludge	583980	150 l/capita/annum/(250 -working days)	~350 KLD

There are 7 STPs in the city, their design capacity and utilised capacity are mentioned in the table below:

Table 2: List of STPs and their utilisation in Dehradun

Sl. No.	STP	Design capacity (MLD)	Utilized capacity as of March, 2020
1	Kargi	68	20% (14 MLD)
2	Motharawala-I	20	100% (20 MLD)
3	Motharawala-II	20	55% (11MLD)
4	Indranagar	5	>100% (5.9 MLD)
5	Jakhan doon Vihar	1	33% (0.33 MLD)
6	Salawala	0.71	55% (0.38 MLD)
7	Vijay Colony	0.42	68% (0.3MLD)

All the STPs mentioned in the above table runs on Sequential Batch Reactor technology (SBR). Kargi STP receives 25-30 trucks FSS daily, the trucks discharge septage at a designated decanting station within the STP premises. Currently, there is no properly designed co-treatment facility, FSS is being discharged directly to STP without any preliminary treatment

Figure 4: Private vacuum tanker discharging FSS into a chamber connected to MPS in Kargi STP



Source: Photo credit Shantanu/NIUA 2020

#### 2.1.4 Disposal/ Reuse

The effluent from all the STPs including Kargi STP is reported to be within the CPCB prescribed discharge standards. However, some operational issues are faced due to addition of FSS while directly discharging into MPS; reported during interview with Jal Sansthan Officials The treated wastewater is disposed into the river and the sludge is used for gardening within the STP premises as well as for farming in the nearby villages.

## DESIGN CONSIDERATIONS

This chapter of the guidebook details the design calculations of co-treatment units. The units recommended are based on the spare capacity available of the dewatering units and the reactors. A compatibility check of existing STP units with incoming characteristics of FSS was studied first, see annexure 6.5. Estimation of volume of faecal sludge being received at STP, see table 3:

### 3.1 Design basis for co-treatment facility

Table 3: Estimation of volume of faecal sludge received at STP

FSS generation (received at STP)	Value	Unit
Monday to Friday	25	tankers/day
Saturday and Sunday	40	tankers/day
Capacity of tankers	3	m <sup>3</sup>
Capacity of tankers	5	m <sup>3</sup>
<b>Assumptions</b>		
Avg. no of trucks	30	trucks/day
70% of trucks are 5m <sup>3</sup> capacity	20	m <sup>3</sup>
30% of trucks are 3m <sup>3</sup> capacity	10	
Vol. of FSS considered	130	m <sup>3</sup>

Table 4: Sewage, faecal sludge and septage characteristics

Parameters	Designed influent-Sewage	Designed effluent-Sewage	Current inlet -Sewage	FSS
BOD (mg/l)	250	<10	163	20,000
COD (mg/l)	400	<100	350	45,000
TSS (mg/l)	500	<10	320	35,000

SOURCE: NIUA REPORT 2019

### 3.2 Proposed co-treatment units

The units can be developed on pilot basis, which is designed on an average current FSS inflow. STPs with similar technology and running on similar conditions in the state can replicate this process of treatment with prior feasibility study, see annexure 6.5. The capacity of treatment can be gradually increased later based on the performance and inflow.

Receiving chamber followed by coarse screen and fine screen  
 Emptying time of one truck of 5000 litres capacity = 10 minutes  
 Discharge = 500 lpm = 0.008 m<sup>3</sup>/s

A receiving chamber with an inlet is required for offloading the faecal sludge to the collection tank. It would be desirable if the operator of a tanker discharges FSS by opening 50% of the valve of the tanker. The receiving chamber should have adequate hydraulic properties to carry the slurry/liquid sludge without deposition and the screen should be able to separate the floating solids from the sludge.

### 3.2.1 Channel design

As per design recommendation by Kevin Tyler in his book on 'Faecal Sludge and Septage Treatment- A Guide for Low and Middle Income Countries', and also given the relatively small discharge flows received at most plants, it will be sufficient to use the following criteria to size the coarse screening chambers.

- Width: minimum 300 mm, preferably 450 mm to allow easy access;
- Depth: minimum 500 mm, preferably 750 mm;
- Floor slope: 1 in 80 (1.25 per cent)

Considering the suggestion provided by Kevin Tyler, the receiving chamber specification are described as follows:

The inlet (mouth) of the receiving chamber should be spill proof with diameter of the mouth to be 4 inches wide ( i.e.100 mm). The chamber shall have a depth of 1000 mm, breadth 450 mm and length 2250 mm. The inlet should be preferably fixed with hose pipe of 3-4ft for both the channels. This pipes when not in use should be hanged with a hook (at a height of 4ft from the base). An emptier should connect this hose pipe to discharge mouth of the tanker and then slowly open the valve. The hose pipe must be cleaned with water on regular basis to avoid deposition and drying of sludge in the pipe. A slope of 2% shall be provided towards the coarse screen to accommodate ease of flow. Two channels should be constructed in parallel, so that one channel remain functional while the other undergoes for cleaning and maintenance.

There shall be the provision of rain shed to be installed at a height of 3-4 ft from the top base of the receiving chamber in both transverse and longitudinal direction covering the entire receiving chamber, with a downward slope of 2% in the transverse direction". This rain shed material must be made of transparent polycarbonate material and supporting structure of zinc galvanized metal.

### 3.2.2 Coarse screens

A coarse bar screen made of stainless steel of 316 grade with 25 mm spacing should be provided at an angle of 135° to the direction of flow or 45° to the vertical axis. The screen should be placed in the chamber at a distance of 1000 mm from the inlet. The particular screen should be removable and should be placed through casing in the inner side of the wall.

Dimension of the coarse screen

Height from the bottom of the tank = 600 mm

Spacing between bars = 25 mm

Width of the circular bars = 10 mm

**No. of bars required (n) is calculated below**

Total breadth of chamber = (no. of circular bars (n) X Width of circular bars) + (no. of circular bars (n) + 1) X Spacing b/w bars

$$450 = 10 \times n + (n+1) 25$$

$$\text{no. of bars (n) in a channel} = 12$$

$$\text{*no of clear spacing a channel} = 13$$

### 3.2.3 Fine screens

Typically used to remove material that may create operation and maintenance problems in downstream processes, particularly in systems that lack primary treatment. Typical opening sizes for fine screens are 1.5 to 6 mm (0.06 to 0.25 inches) and can be placed at an angle of 120 degree to the direction of flow or 60 degree to the vertical axis and also must be placed at a minimum distance of 200mm from the coarse screen end in order to accommodate the racking staff for cleaning purpose. For this case, a fine screen of opening 6 mm in size is considered to be installed after coarse screen. This should be hung with the hinges supported by wall of the outlet. This should be a removable arrangement. Followed by this an outlet of 6 inches diameter should be placed at the bottom of the tank to convey faecal sludge to the next unit -homogenization tanks.

Figure 5: Plan and cross section for receiving chamber

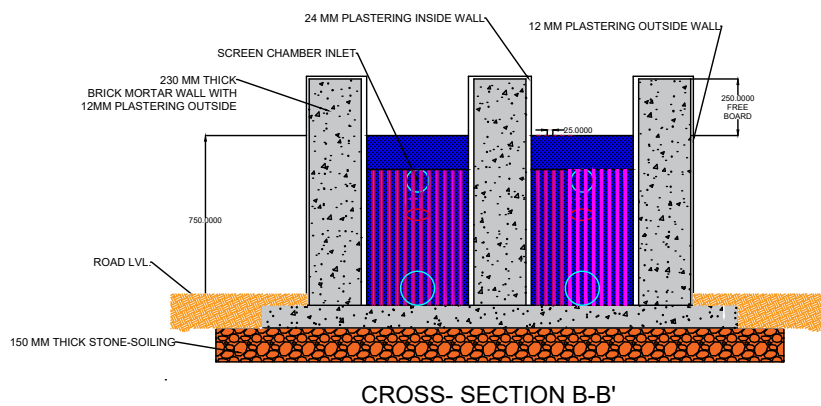
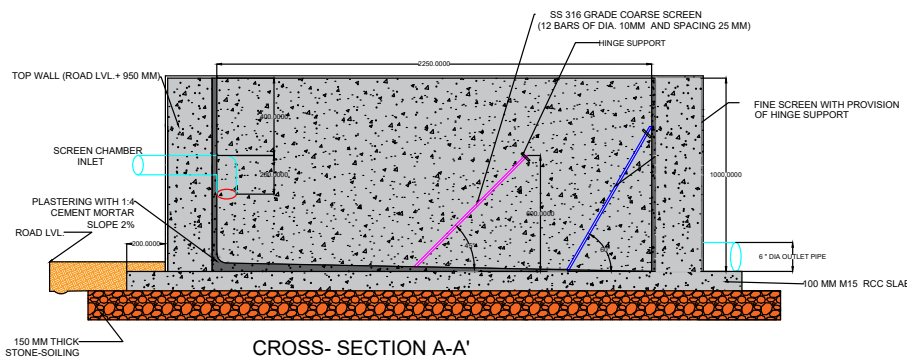
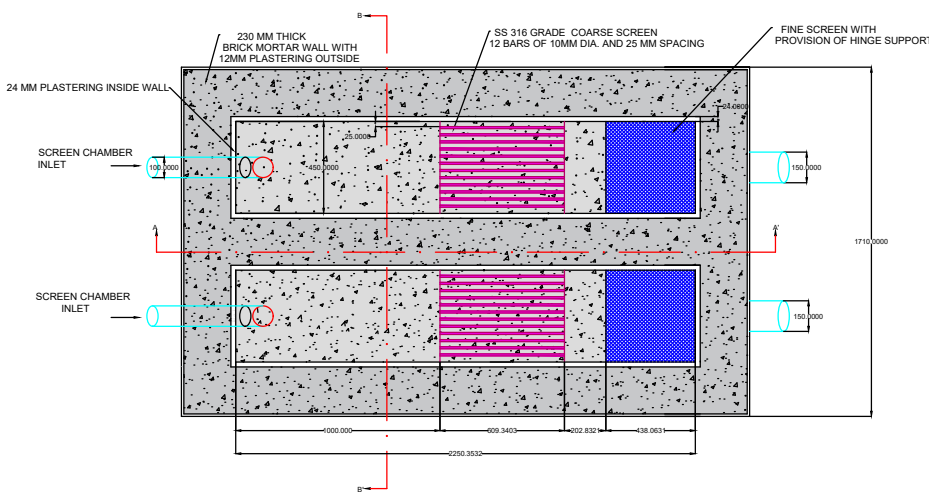

Project Name

Co-treatment of Faecal Sludge at Kargi Sewage Treatment Plant

Note:

- All dimensions are in 'mm' unless mentioned otherwise.
- All dimensions are to be checked and co-related with the design drawings and structural drawings. Any discrepancy or omission shall be brought to notice.
- All inner dimensions are excluding plastering in design drawings and including plastering in structural drawings unless otherwise mentioned.
- All plastering to be of waterproofing nature.
- Use UPVC pipes (25.4mm, 55mm, 110mm & 150 mm dia (1", 2", 4" & 6")) which can withstand pressure of 6kg/cm<sup>2</sup>
- All BBM walls to be with cement mortar ratio of 1:5 unless otherwise mentioned. All soling to be with sufficient sand filling at top surface

TITLE: RECEIVING CHAMBER

SHEET NO: 1

SCALE: 1:25



Sanitation Capacity Building Platform

Source: Prepared by SCBP

Note: for display purpose only, full scale plan can be accessed with the link provided print on A3 page only:

<https://drive.google.com/drive/folders/1wxFTcSbtIVFycGuTkXvKNzOtM-W-Ne-l>

### Design of grit chamber

A chamber of minimum 0.5 m<sup>3</sup> capacity would be required for 1 minute of retention time but based on oversize design of receiving chamber recommended earlier, receiving chamber will be supposedly sufficient to arrest grits as well. Hence, it is not proposed in the facility.

### 3.2.4 Additional requirements for O&M - Sprayer

A tap with sprayer should be installed near to the influents to clean the hose pipe of the tanker, inlet of the chamber and screens.

### 3.2.5 Homogenization tank cum stabilization tank

Faecal sludge emptied by tankers from various establishments have different characteristics, so these tanks will store the faecal sludge and septage for 48 hours and a homogenized faecal sludge should be passed to next unit. The tanks should be installed in parallel with two units of suggested sizes. As estimated, faecal sludge generation would be 130 KLD for the designed period. Hence, a unit of 260 m<sup>3</sup> capacity of a tank should be installed. Moreover, the capacity of the homogenization tank is designed based on the hydraulic and loading capacity of the centrifuge unit. The tanks to be installed should be made up of Reinforced concrete cement (RCC).

Requirements for Co-treatment process (Specifications):

RCC tank volume= 260 KL

Shape = Rectangular

Depth = 3m (assumed)

Length = 13.35 m

Width = 6.5 m

Slope = 2 %

The solid concentration of FS to be discharged into centrifuge is 35 kg/cum. Moreover, the centrifuge is designed for the solid concentration of 50<<100 kg/cum. Thus, TS concentration of FSS for treatment at centrifuge is complying with the design. The area required for homogenisation tanks is 173.55 m<sup>2</sup> and area available for in the STP premise is 1040 m<sup>2</sup>.

Additional requirements for O&M in the tank: At least three manholes and three vents should be installed in the tank. The vent should have cowl on top of the vent and the height of the vent should be greater than 6ft. The FS collected in the tank for two days with 260 KL should be pumped into sludge sump on third day.

The sludge settled in the bottom (0.5 m from the bottom) of the tank should be pumped into dedicated sludge drying beds in every 15 days. The suction mouth of the pump should be placed (with height adjustable) at above 0.5 m from the bottom. The pump used for discharging FS in the tank can be used to discharge settled sludge with the help adjustable placement of the pump.

### 3.2.6 Pump requirements for Homogenisation Tank

Table 5: Pump calculations

<b>Discharge (Q)</b>	0.018 m <sup>3</sup> /sec
<b>Diameter of the pipe taken</b>	200 mm
<b>Height (suction head + discharge head)</b>	3 m HT + 3.5m + 3m (Sump) = ~10 m
<b>Total Length of Pipe (assumed)</b>	50 m
<b>Overall efficiency</b>	0.7
<b>Co-efficient of friction</b>	0.013
<b>Velocity of FS in pipe</b>	0.58 m/sec
<b>Frictional head loss in pipe</b>	0.222 m ( $4flv^2/2gd$ )
<b>Manometric head (Hm)</b>	10.04 m
<b>Unit weight of Septage assumed</b>	(1200 kg (density of septage) * 9.81/1000) kN/m <sup>3</sup> = 11.772 kN/m <sup>3</sup>
<b>Break Horse Power (BHP)</b>	(unit weight of Septage(kN/m <sup>3</sup> ) * Discharge(m <sup>3</sup> /s) * (Total manometric head(m)) / 0.746 * overall efficiency) = 4.147
<b>Power required</b>	HP = 0.99 BHP; 1HP = 746 W 4.12 / 0.99 = 4.1889 HP or 3124.93 W

Therefore, a 5 hp pump submersible pump should be installed in the HT. Two pumps would be required; 1 working and 1 standby. The pump suction pipe should be placed 0.5 m above the bottom surface of the tank.

Figure 6: Plan and cross section of homogenisation tank

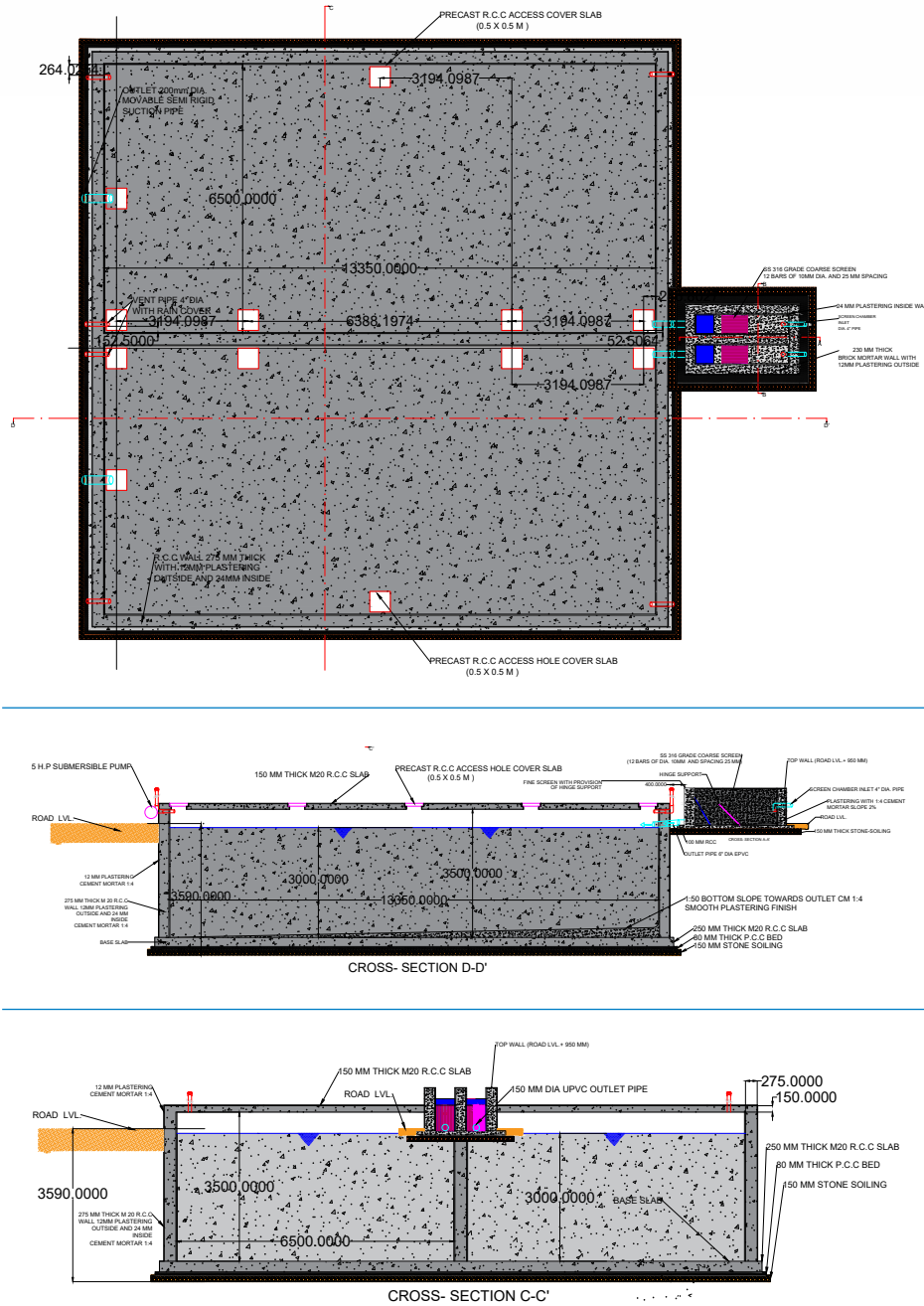

Project Name

Co-treatment of Faecal Sludge at Kargi Sewage Treatment Plant

Note:

- All dimensions are in 'mm' unless mentioned otherwise.
- All dimensions are to be checked and co-related with the design drawings and structural drawings. Any discrepancy or omission shall be brought to notice.
- All inner dimensions are excluding plastering in design drawings and including plastering in structural drawings unless otherwise mentioned.
- All plastering to be of waterproofing nature.
- Use UPVC pipes (25.4mm, 55mm, 110mm & 150 mm dia (1", 2", 4" & 6")) which can withstand pressure of 6kg/cm<sup>2</sup>.
- All BBM walls to be with cement mortar ratio of 1:5 unless otherwise mentioned. All soiling to be with sufficient sand filling at top surface

TITLE: HOMOGENIZATION TANK

SHEET NO: 2

SCALE: 1:60



Sanitation Capacity Building Platform

Source: Prepared by SCBP

Note: for display purpose only, full scale plan can be accessed with the link provided, print on A1 page [https://drive.google.com/drive/folders/1b1Uc75sUZFFyVYDIFQp\\_lpobQv-DVdbk](https://drive.google.com/drive/folders/1b1Uc75sUZFFyVYDIFQp_lpobQv-DVdbk)

### 3.2.7 Dewatering using centrifuge unit

Centrifugal thickening and dewatering of sewage sludge is a high speed process that uses the force from rapid rotation of a cylindrical bowl to separate wastewater solids from liquid. Centrifuges have been used globally in wastewater treatment since 1930s. Thickening before dewatering reduces the tank age storage by removing water. Dewatering removes more water and produces a drier material referred to as “cake” which varies in consistency from that of custard to moist soil.

**Table 6: Compatibility calculation for FS dewatering at centrifuge unit**

Details	Values	Remarks
No of centrifuge provided in the STP for sewage sludge	4 no.s	Only 1 centrifuge is currently in operation
Centrifuge required for FS treatment	1 no.	Will be sufficient for co-treatment purpose
Capacity provided for each centrifuge (Sewage)	25 m <sup>3</sup> /hr	Centrifuge designed
Hours of operation for FSS treatment	10.4 hrs	<<Provided 20 hrs of operation for Sewage sludge
Solids content before centrifuge (FSS)	3.5%	Feed 3.5% with DWPE dosing and air floatation, 3.5%-4% solid content is within design limit, further, expected cake solid % is desirable in the range of 25% to 35%.
Flow rate Septage	260 KL	
Expected Mean TSS Concentration (FSS)*	300 kg/m <sup>3</sup>	Expected mean TSS content of sludge post 'Sludge thickening unit and DWPE dosing' from the Centrifuge
Operational days for centrifuge to run for FS dewatering	14 days/month	On an alternate day basis
Total dried faecal sludge generated in per centrifuge operation (28.82 m <sup>3</sup> /d * 300 kg/m <sup>3</sup> )/ Dewatered sludge cake	8646 kg/d	Can be further dried (for pathogen removal) on proposed drying beds
Filtrate volume (centrate)	231.18 m <sup>3</sup>	To be transported to main pumping station for treatment with sewage

\*subject to Centrifuge design specification committed by service provider.

Solid cake produced would still have moisture and pathogen, hence it would be appropriate to sun-dry the centrifuged sludge on a sludge drying bed to kill the pathogens and further reduce the moisture in the sludge.

### Sludge thickening and Dewatering polyelectrolyte (DWPE) dosing

Before dewatering the sewage sludge at centrifuge it is conditioned by air floatation and DWPE dosing at thickening tank similarly Faecal sludge and septage will follow the same process. The amount of DWPE dosing required from time to time will be estimated by testing in the laboratory at Kargi STP.

### 3.2.8 Sludge drying beds

Drying beds are one of the simplest and oldest techniques for sludge dewatering. They are impermeable beds filled with different layers of gravel and sand. Draining pipes are incorporated in the bottom of the beds. Sludge is applied in layers on the top of the beds. Drying is achieved by evaporation and gravity percolation. The effluent (percolate) that is collected in the drainage pipes should be discharged into main pumping station so that it get treated with sewage. This particular unit is not available at the STP. Hence, sludge drying beds are suggested with the following specifications:



**Table 7: Calculation for requirement of sludge drying beds**

<b>Dewatered sludge from Centrifuge</b>		
i	Solid loading on drying beds (m <sup>3</sup> /day) i.e. 3 days/week	28.82
ii	Hydraulic loading depth/ day	0.3
iii	Size of beds	13.75 m X 7 m X 0.30 m (sludge application)
iv	Drying time	3 days/week
v	Loading and Scrapping of dried sludge	1 day each
vi	Total days per bed	5 days
vii	Total no. of drying beds required	3 nos. Working + 1 no. Standby = 4
viii	Area required/day for one bed	96.25 sq.m
ix	Total area required	385 sq.m (4*96.25) Note: for 5 days
<b>2. Beds required for drying of bottom sludge of the homogenisation tank (desirable for O&amp;M )</b>		
i	Sludge produced	43 m <sup>3</sup>
ii	Designed capacity	45 m <sup>3</sup>
iii	Size of beds	17m X 8.5 m X 0.30m (sludge application)
iv	Drying period	10 days
v	No. of beds required	2
vi	Loading and scrapping of dried sludge	1 day each

Two different sizes of SDBs are recommended, one for dewatered sludge and another for sludge decanted from homogenisation tank are recommended, see table 7. with sand layer ranging from 230 – 300 mm depth. The top layer should have Jolly bricks filled with sand. This will prevent repeatedly refilling of sand on the bed. The sand should have a uniformity coefficient of not over 4.0 and effective size of 0.3 to 0.75 mm. The piping to the sludge drying beds should be designed for velocity of at-least 0.75 m/s. The sludge is placed on the bed in 20–30 cm layers and allowed to dry. Sludge cake removal is manual by shovelling into wheel-barrows, trucks, scraper, or front-end loader. Usually, the drying time is taken 10-15 days but as FS is dewatered through centrifuge hence beds are proposed for killing pathogens through open drying and storing. The drying period taken for dewatered sludge is 3 days and for settled sludge is 12 days.

There shall be the provision of rain shed to be installed at a height of 7-8 ft from the top base of the Sludge drying beds in both transverse and longitudinal direction covering the entire beds, with a downward slope of 2% in the transverse direction.

This rain shed material must be made of transparent polycarbonate material and supporting structure of zinc galvanized metal.

Total beds proposed are four in nos. in which three will be in working and one will be on standby. As it is a pilot scale project, it is suggested by UJS to cut the cost, one bed in standby will be used for O&M of the Htank and later based on requirement no. of beds can be increased.

Note: In case of pump failure, the Homogenisation tank can be emptied by desludging vehicle in order to remove the settled sludge and be emptied on sludge drying beds.

Figure 7: Plan and cross section of sludge drying beds for dewatered sludge

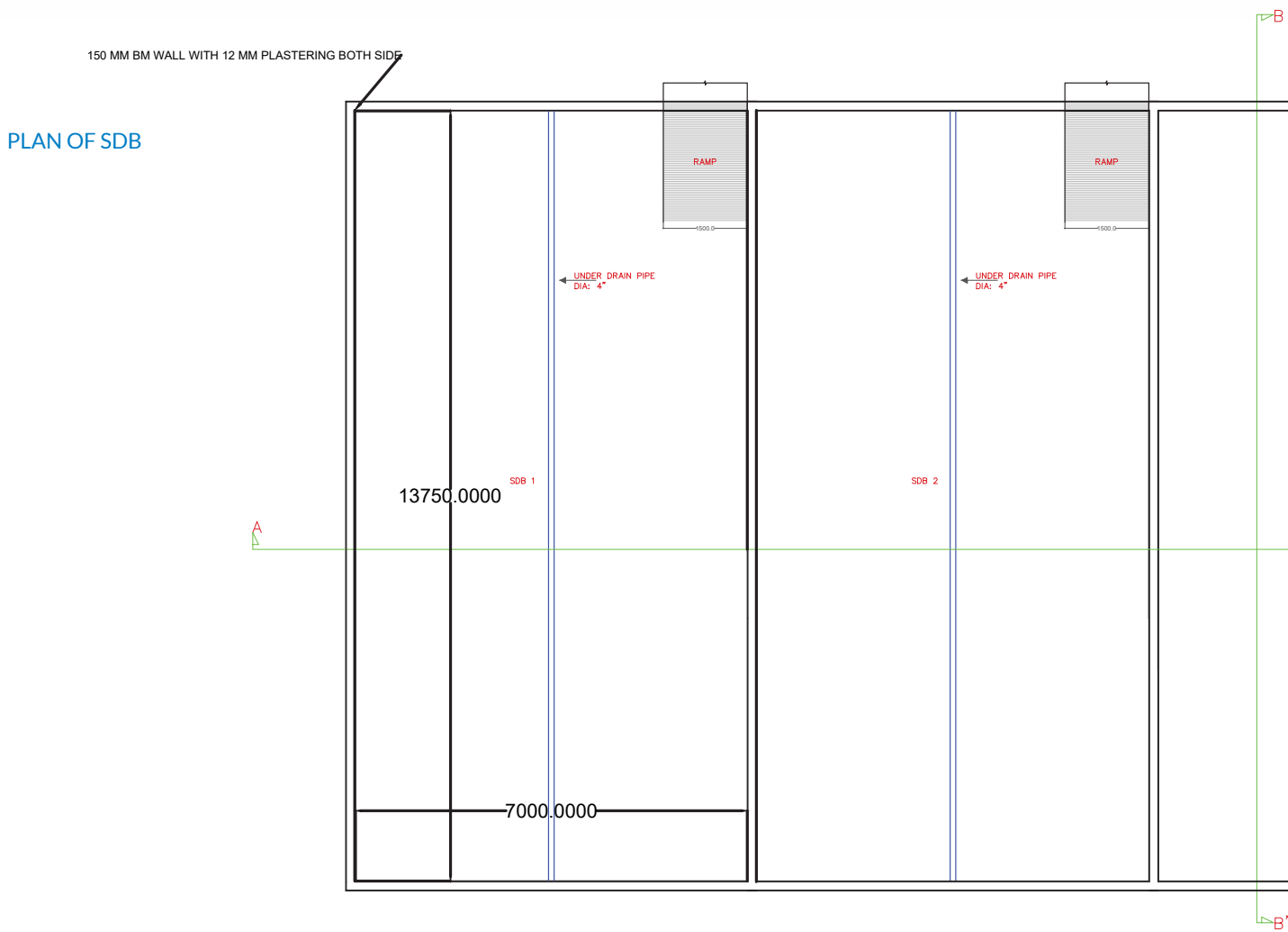

SECTION AA'

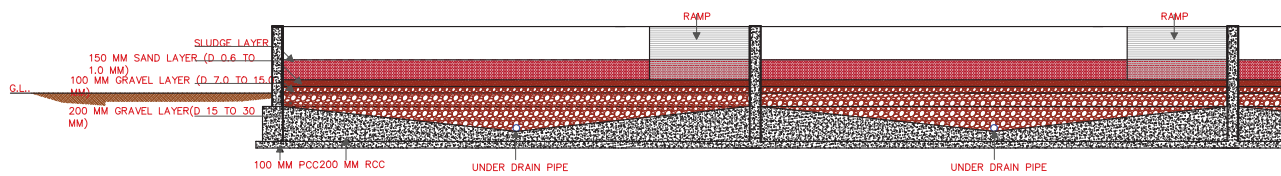

SECTION BB'

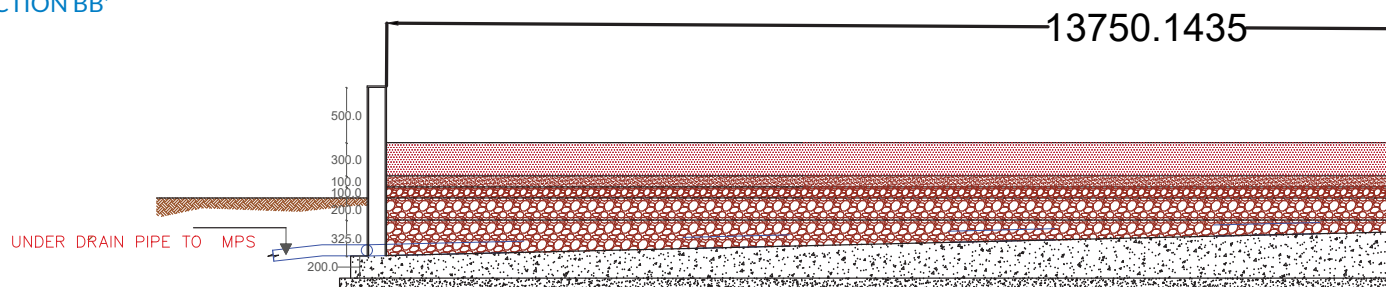

Note: For display purpose only, full scale plan can be accessed with the link provided, print on A1 page only  
<https://drive.google.com/drive/folders/1R77RwQpXM4-7gmPjkXlrg79UEPv6oVMg>

Project Name

Co-treatment of Faecal Sludge at Kargi Sewage Treatment Plant

Note:

- All dimensions are in 'mm' unless mentioned otherwise.
- All dimensions are to be checked and co-related with the design drawings and structural drawings. Any discrepancy or omission shall be brought to notice.
- All inner dimensions are excluding plastering in design drawings and including plastering in structural drawings unless otherwise mentioned.
- All plastering to be of waterproofing nature.
- Use UPVC pipes (25.4mm, 55mm, 110mm & 150 mm dia (1", 2", 4" & 6")) which can withstand pressure of 6kg/cm<sup>2</sup>.
- All BBM walls to be with cement mortar ratio of 1:5 unless otherwise mentioned. All soling to be with sufficient sand filling at top surface

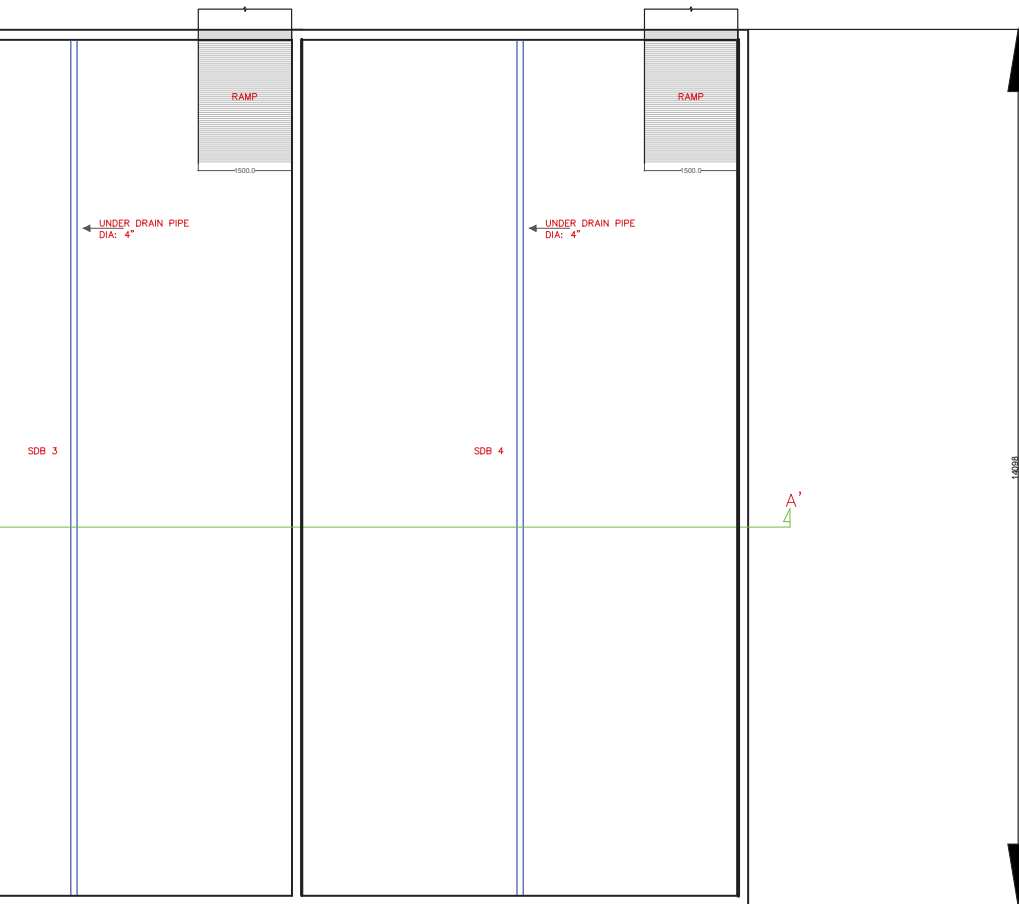

TITLE:  
DEWATERED SLUDGE  
HOLDING BEDS

SHEET NO: 3

SCALE: 1:80

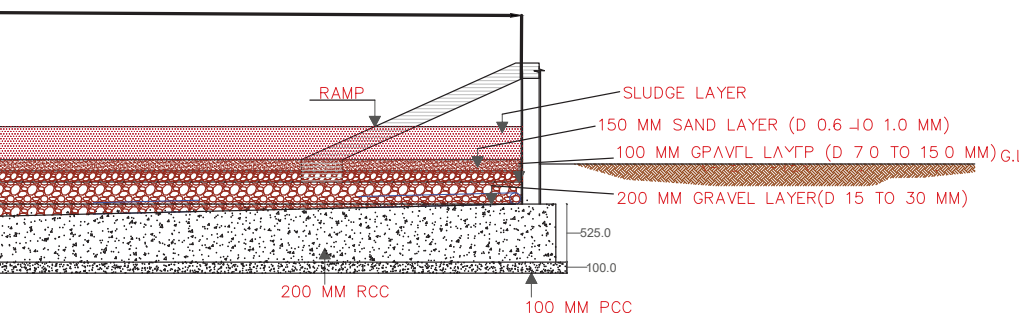
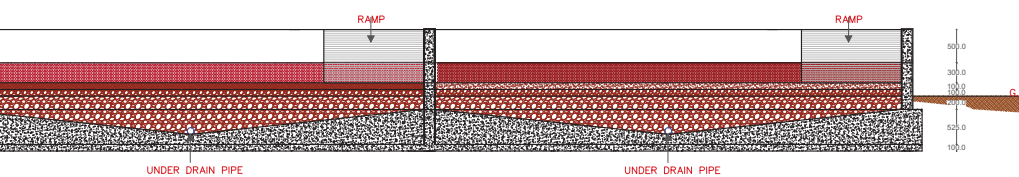

Sanitation Capacity  
Building Platform

Figure 8: Plan and cross section of sludge drying beds for bottom sludge of homogenisation tank

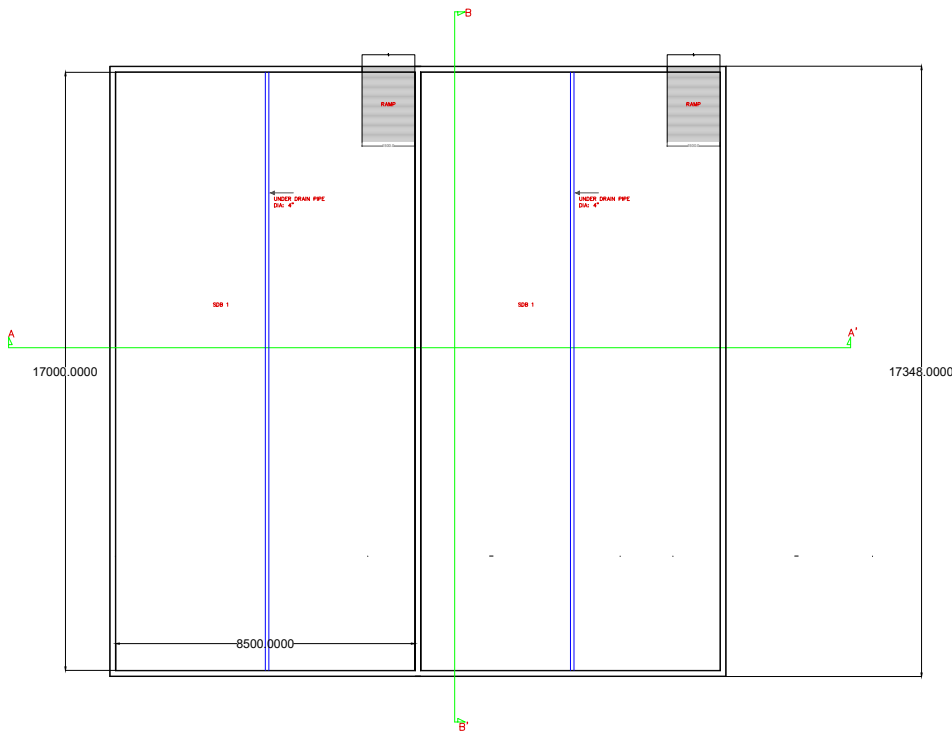

**Project Name**

Co-treatment of Faecal Sludge at Kargi Sewage Treatment Plant

**Note:**

- All dimensions are in 'mm' unless mentioned otherwise.
- All dimensions are to be checked and co-related with the design drawings and structural drawings. Any discrepancy or omission shall be brought to notice.
- All inner dimensions are excluding plastering in design drawings and including plastering in structural drawings unless otherwise mentioned.
- All plastering to be of waterproofing nature.
- Use UPVC pipes (25.4mm, 55mm, 110mm & 150 mm dia (1", 2", 4" & 6")) which can withstand pressure of 6kg/cm<sup>2</sup>.
- All BBM walls to be with cement mortar ratio of 1:5 unless otherwise mentioned. All soling to be with sufficient sand filling at top surface

**SECTION AA'**

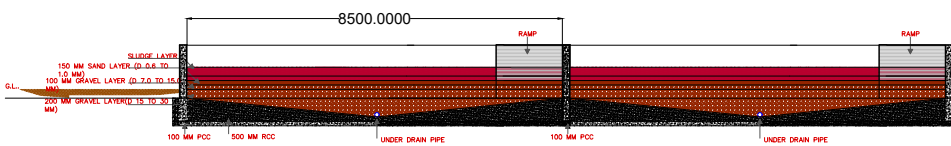

**TITLE:**  
SLUDGE DRYING BEDS  
(HOMOGENIZATION TANK)

**SHEET NO:** 4

**SCALE:** 1:70

**SECTION BB'**

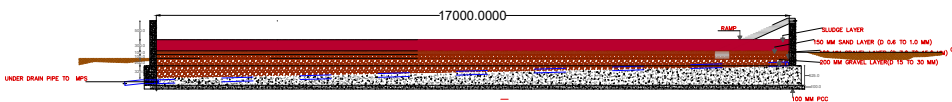

Sanitation Capacity Building Platform

Source: Prepared by SCBP

Note: for display purpose only, full scale plan can be accessed with the link provided print on A1 page only  
<https://drive.google.com/drive/folders/1R77RwQpXM4-7gmPjKXlrg79UEPv6oVMg>

The filtrate or leachate produced from the sludge drying beds have high nutrient composition. Similarly, the leachate from the sludge drying beds which is produced from FS, is still not in condition to be discharged into environment. Hence, the filtrate should undergo oxidation treatment in the SBR. Therefore, leachate should be discharged into main pumping station so that it gets treated with inflow sewage.

### 3.3 Process flow diagram for co-treatment

A process flow diagram explains the proposed units and existing units of STP to be utilised for co-treatment of FS, see figure

Figure 9: Process flow diagram of co-treatment units

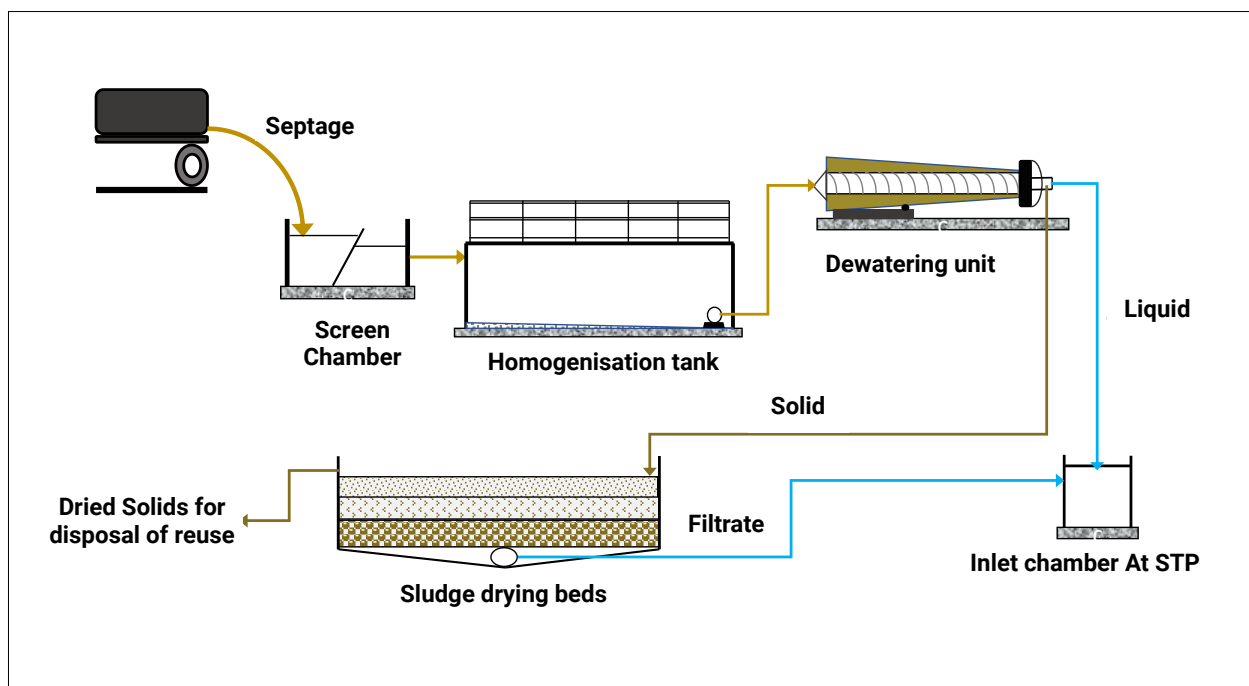

Source: Prepared by SCBP

Table 8: Proposed modules and their sizing

Sl. No.	Description	Dimensions/details	Area (m <sup>2</sup> )
1	Vacuum tankers	30 tankers/day	
2	Receiving station chamber	2250 mm X 450 mm X 1000 mm LWD X 2	2.025
(I)	Channel		
(II)	Coarse screen and fine screen	600 mm X 450 mm HW X 2	
3	Homogenisation tank	13350 mm X 6500 mm X 3000 mm LWD	173.55
4	Submersible pump	5 hp	
5	Sludge drying beds	13.75 mm X 7 mm X 300 mm SWD X 4	385
6	Sludge drying beds for settled sludge in HT	17000 mm x 8500 mm x 300 mm SWD x 2	289
Total area required			850

# OPERATION AND MAINTENANCE

---

It is essential to regularly operate and maintain the co-treatment facility for its smooth function and improved life span. It is necessary that all officials / engineers and staff of STP have a handout of the O&M activities and familiarize themselves with the standard operating procedures. Sign boards with O & M schedules should be displayed at the site. The operator must be familiar with the operating procedures before he starts to operate and maintain the Co- treatment facility. It is a must that the operator undergoes a training program dedicated to O&M of STP and handling Co-treatment facility from the service provider. An operating procedure steps to be followed for co-treatment is presented in a check list format, see annexure

## 4.1 Truck arrival and faecal sludge decanting

The truck arrives at the STP and follows the road leading towards the screening chamber – Decanting Station. It should be the responsibility of the respective vacuum tanker operator to connect truck's outlet with the screening chamber through hose pipe and discharge the faecal sludge with half of the opened valve into the screening chamber. Spillage of FS at the decanting station should be avoided. A STP operator should monitor the decanting process and can fine the operator if spillage occurs due to negligence. The working hours to decant FS should be 7 am to 4.30 pm. Record of collection, transport & disposal of FSS should be duly filled and signed by the STP operator before allowing tanker to enter the STP, see volume 2 table no. 5 and 6. For safety measures to be followed and personal protective equipment to be taken while handling faecal sludge and septage, see for SOP for cleaning sewers and septic tanks (<https://bit.ly/3OF8qKP>); and the same can be adopted.

## 4.2 Screening chamber

After decanting of faecal sludge by the trucks in a whole day, the screening chamber should be cleaned at the end of the day but before sunset. The solid waste and the grit deposited and screened at the unit should be removed manually and disposed with trash collected by other screens of the STP. The operator should wear protective equipment such as gloves and make sure to not have skin contact with the faecal sludge.

## 4.3 Tap with sprayer

A water tap with a sprayer as an additional equipment should be installed near to inlet of screen chamber. This should be used for cleaning in case of spillage by tankers and blockage at screen. For safety reasons, this tap can be used in case of accidental spillage. In case of spillage during decanting operation, based on the intensity of the spillage the staff responsible for supervision should get the affected area washed by using clean water from the sprayer and sprinkle the lime on it.

#### **4.4 Homogenisation tank**

Homogenization tank does not require any external operation as the flow works by gravity and it's largely serve as a holding tank. The tank should not retain FS for more than 4 days. Cowl should be provided on the top of the vent to prevent entry of flies and any insect into the tank. It is possible that the bottom surface of the tank (area below suction head during regular operation) gets accumulated with hardened sludge over the time. This sludge may have high nutrients and pathogens hence it should be treated as well. It would be appropriate to pump the bottom sludge to dedicated sludge drying beds in every 15<sup>th</sup> day. or less as decided upon during trial runs.

#### **4.5 Electricity**

The cost of running the electrical equipment, generator sets and their accessories have already been included in the previous i.e. DPR of the plant. As the modules which would be required for co-treatment are not being used currently, therefore, the electricity requirement and related cost to run the pumps installed at sludge sump and filtrate sumps have not been included in this technical note.

## RE-USE OF BY-PRODUCTS FROM FSS TREATMENT AT KARGI STP

---

Reuse and revenue generation potential of the sludge generated from the co-treatment should also be taken into consideration. Dried sludge is not stabilized, but additional composting will allow to recycle nutrients and organic matter into agriculture. The dried sludge generated from FSS is very high in nutrient content and has good potential for use in agriculture. The project should explore the possibility of co-composting of sludge generated from FSS treatment with organic municipal solid waste, which further helps to improve the nutritional value of compost and reduce the pathogen content. In order to ensure there is a good market for manure generated from co-treatment, there is a need to sensitize the end users about the benefits of organic compost and incentives are needed from the authority to promote its use. There are examples from Bangladesh, Sakhipur Faecal sludge Treatment Plant where the treated sludge from FSTP is co-composted with organic municipal solid waste. The manure here has gathered popularity among local farmers. The dried sludge should be stored in store yard and should be transferred to co-composting plant to prepare manure and further use it for agricultural purpose. Presently, treated wastewater is discharged into Bindal River. This treated wastewater can be used for irrigation and gardening.



## REFERENCES

---

NIUA (2019). Co-Treatment of Septage at STPs of Ganga Towns in Uttarakhand

Taylor, K. (2018) Faecal Sludge and Septage Treatment: A guide for low- and middle-income countries, Rugby, UK, Practical Action Publishing, <<http://dx.doi.org/10.3362/9781780449869>

Narayana, D. (2020). Co-treatment of Septage and Faecal Sludge in Sewage Treatment Facilities. IWA Publishing.

UUSDIP. (2012). Detailed Project Report – 68 MLD capacity Sewage Treatment Plant at Kargi, Project Implementation Unit, Asian Development Bank (ADB)

UUSDIP. (2012). Environmental process design – DPR of 68 MLD capacity Sewage Treatment Plant at Kargi, Project Implementation Unit, Asian Development Bank (ADB)

# ANNEXURE

## 7.1 Flow diagram of Kargi STP

Figure 10: Process flow diagram of the STP

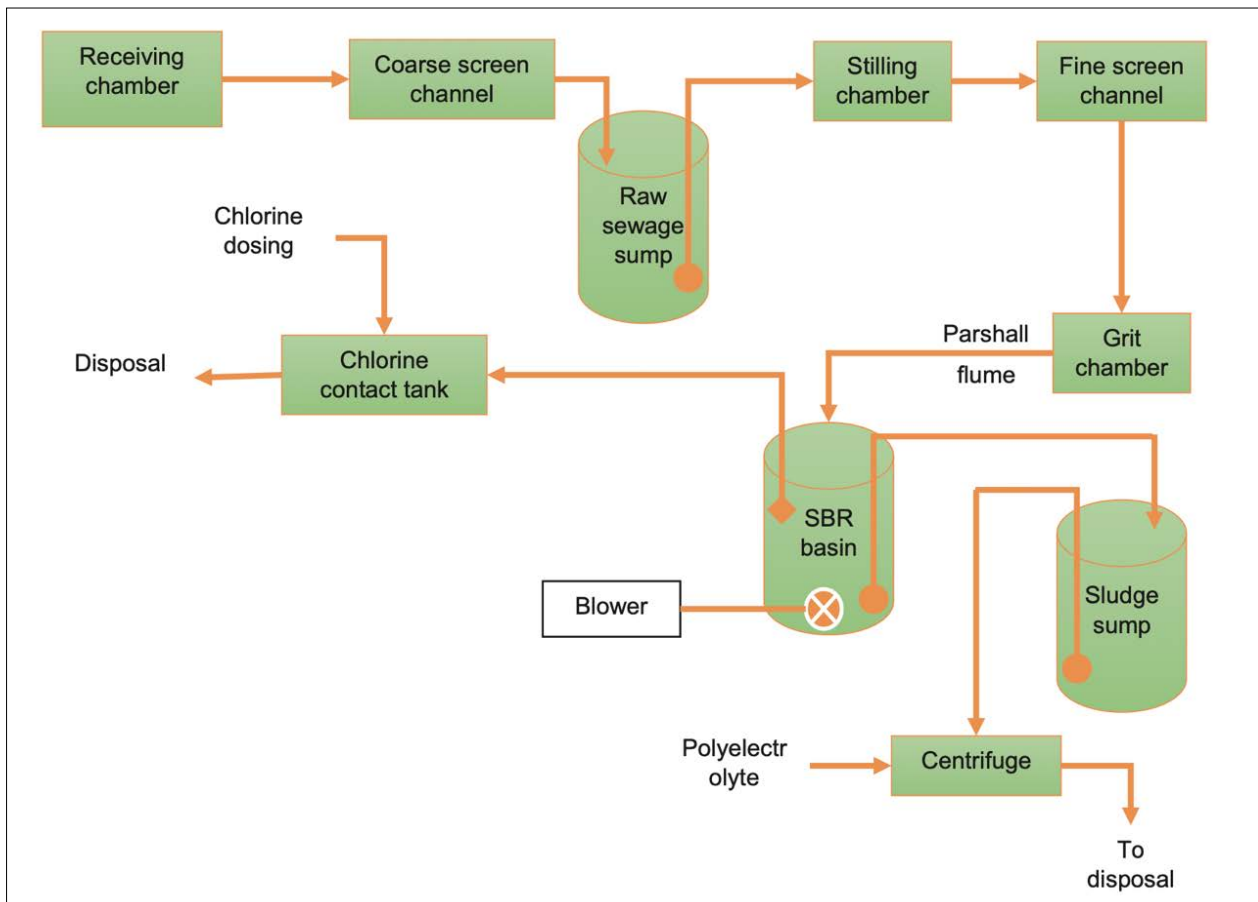

Source: NIUA - IIT Roorkee 2019

## 7.2 Unit process and operations of STPs with dimensions

Table 9: Units dimensions of STPs

S.no.	Description	Dimensions	No.
1.	Receiving chamber	Volume - 53.13 m <sup>3</sup>	1
2.	Mechanical coarse screen	5.75 m x 1.4 m x 1.35 m SWD	2
3.	Manual coarse screen	5.75 m x 1.4 m x 1.35 m SWD	1
4.	Raw sewage sump (wet well)	16.5 m Dia. x 2.56 m SWD	1
5.	The raw sewage pumping station	16.5 m Dia. X 5.0 m ht.	1
6.	Stilling chamber	4.3 m x 4.2 m x 3.0 m SWD	1
7.	Mechanical fine screen	7.25 m x 1.45 m x 1.25 m SWD	1
8.	Manual fine screen	7.25 m x 1.45 m x 1.25 m SWD	2
9.	Grit chamber	9.0 m x 9.0 m x 0.9 m SWD	2
10.	SBR/C-Tech basin	60.45 m x 33.5 m x 5.8 m SWD	4
11.	Chlorine contact tank	50.0 m x 1.9 m x 1.5 m SWD	1
12.	Chlorination room	10.0 m x 5.0 m x 4.5 m ht.	1
13.	Sludge sump	10.0 m x 8.55 m x 3.5 m SWD	1
14.	Sludge pump house	12.0 m x 10.0 m x 4.5 m ht.	1
15.	Sludge drying area	Area = 475 m <sup>2</sup>	
16.	Centrifuge house	10.0 m x 6.5 m x 9.0 m ht.	1
17.	Blower room	37.0 m x 10.0 m x 10.0 m ht.	1

## 7.3 Summary of study and analysis conducted by IIT Roorkee

The STP is designed for an average flow of 68 MLD and a peak flow of 153 MLD. Composite sampling, representative samples were collected at a regular time interval of 3-h on 14-15th June 2019. The flow rate was recorded by pump operation. The representative samples were then integrated by mixing together the portions of the individual samples relative to the flowrate at sampling time to make a composite sample. Analyses of alkalinity, COD, BOD, TSS, NH<sub>4</sub>-N, NO<sub>3</sub>-N, and PO<sub>4</sub>-P were carried out as per the Standard Methods (APHA, 2012) and 434 presented in Table. The results show that almost all parameters satisfy the design outlet quality

Table 10: Sewage test result by IIT Roorkee

S.No.	Parameters	Unit	Raw sewage	Outlet	Desired Effluent Quality
1	Alkalinity as CaCO <sub>3</sub>	mg/L	420	270	-
2	pH		7.1	7.2	-
3	Turbidity	NTU	65	1.8	-
4	BOD	mg/L	298	11	10
5	COD	mg/L	547	33	100
6	TSS	mg/L	406	9	10
7	NH <sub>4</sub> -N	mg/L	45.3	1	-
8	NO <sub>3</sub> -N	mg/L	0.1	4.1	-
9	TN	mg/L	48.6	7.2	-
10	PO <sub>4</sub> -P	mg/L	3.5	0.4	-

Table 11: Septage characteristics analysed by IIT Roorkee

City	Sampling location	pH	Alkalinity (mg/L)	O&G (mg/L)	COD (mg/L)	BOD (mg/L)	TSS (mg/L)	VSS (mg/L)	NH <sub>3</sub> -N (mg/L)	TKN (mg/L)	TN (mg/L)	T-P (mg/L)
Dehradun	1. Niranjapur	11.7	524	2310	45050	28381	7081	4310	98	112	113	310
	2. Brahmaputra	12.9	714	4309	27010	17016	31011	27001	115	122	123	620
	3. Triveni, Bihar	10.6	534	5101	45745	19117	63710	55010	171	189	190	410
	4. Dehaj	9.9	419	5310	21425	15414	27109	21014	141	159	160	437
	5. Bengali Kothi	11.7	721	5219	26575	21134	28101	19017	121	135	136	508

Loading and disposing criteria by IIT Roorkee

Actual COD, BOD, and TSS loading during the day (i.e. 8:00 am to 4:00 pm) was intermittent and higher than design loading capacity. Therefore, during this duration, co-treatment is not possible. To achieve co-treatment at the STP, the septage should be added with inflow sewage between 4:00 pm to 8:00 am. After providing a storage facility, co-treatment can be done during the provided hours.

Assuming the volume of 1 truck/tanker = 3 m<sup>3</sup> Therefore, organic loading of 1 truck/tanker

COD loading = 30000 mg/L x 3 m<sup>3</sup> /truck = 90 kg/truck  
 BOD loading = 20000 mg/L x 3 m<sup>3</sup> /truck = 60 kg/truck  
 TSS loading = 30000 mg/L x 3 m<sup>3</sup> /truck = 90 kg/truck

Table 12: Calculation for septage discharge into STP

Duration	Considering COD	Considering BOD	Considering TSS
	Safe COD loading = 1133 kg/h	Safe BOD loading = 566 kg/h	Safe TSS loading = 906 kg/h
	Septage Tanker load = 90 kg COD/Tanker	Septage Tanker load = 60 kg BOD/Tanker	Septage Tanker load = 90 kg TSS/Tanker
Between 4:00 pm – 8:00 am	Average actual COD loading = 207 kg/h	Average actual BOD loading = 126 kg/h	Average actual TSS loading = 128 kg/h
	1133 kg/h - 207 kg/h = <b>926 kg/h</b> or <b>10 truck/h can be disposed</b>	566 kg/h - 126 kg/h = <b>440 kg/h</b> or <b>7 truck/h can be disposed</b>	906 kg/h – 128 kg/h = <b>778 kg/h</b> or <b>8.6 truck/h can be disposed</b>

Total no of trucks can be disposed = 7 trucks x 16 = 112 trucks

Volume of septage that can be disposed = 112 truck x 3 m<sup>3</sup> / truck = 336 m<sup>3</sup>

## 7.4 Minutes of the meeting for co-treatment at Kargi STP



### Office of Executive Engineer, Uttarakhand Jal Sansthan (South Division), Dehradun

E-mail:- eesouth-ujs-uk@nic.in

Phone No:- 0135- 2742028

Reference No 2542 /E.E(S)/2019-20

Date 05/03/2020

### Minutes of Meeting National Institute of Urban Affairs (NIUA) and Jal Sansthan (South Division) Dehradun

Date: 26 February, 2020

Venue: Office of Executive Engineer, Uttarakhand Jal Sansthan (South Division),  
Dehradun

#### Participants:

1. Shri Maneesh Semwal, Executive Engineer, Jal Sansthan (South Division), Dehradun
2. Shri, Anuj Kumar Pandey, Junior Engineer, Jal Sansthan (South Division), Dehradun
3. Shri Shantanu Kumar Padhi, Sr. Programme Officer, NIUA
4. Shri Doab Singh, Programme Officer, NIUA

This meeting was held in regard to the NIUA's support for implementing septage management at Kargi chowk STP, Dehradun on request of Jal Sansthan Dehradun. NIUA is providing technical support to Jal Sansthan under the MoU between Urban Development Department Uttarakhand and National Institute of Urban Affairs, New Delhi, to promote the safe handling, conveyance, treatment and disposal of septage based sanitation systems of the state and for promoting decentralized sanitation solutions.

NIUA completed an assessment study on co-treatment in collaboration with IIT Roorkee to identify the potential of septage management (co-treatment) at Kargi Chowk STP along with 8 other STPs within the state. The assessment report was formally shared and shared during the State Consultation Meet organized on 29<sup>th</sup> Nov 2019 in Dehradun with support of Urban Development Directorate, Uttarakhand.

Taking the study findings forward, NIUA had a meeting with E.E. Jal Sansthan (South) Dehradun to discuss the overall plan on design, financing and other estimations related to the proposed co-treatment technology at Kargi Chowk STP.

#### Following points were discussed and agreed:

- Kargi Chowk STP is currently receiving 25-30 cesspool trucks (contains septage from domestic and non-domestic establishments every day from Dehradun and nearby areas and discharging directly to the STP.
- There are possibilities of affecting the treatment process of the STP and ultimately the treatment effluent, due to the concentration load of the septage.
- Practicing co-treatment of sewage with septage will be a suitable option for septage management.
- NIUA will prepare a "Design Recommendation for Faecal Sludge and Septage co-treatment infrastructure" at Kargi Chowk 68 MLD STP. That will include design and treatment infrastructure layout for Uttarakhand Jal Sansthan. The budget estimation and DPR will be prepared by Jal Sansthan.

- Designing of the co-treatment facility will be prepared based on the existing faecal sludge and septage load received at the STP which is currently estimated to be more than 30 trucks a day. Uttarakhand Jal Sansthan will only allow the limited number of cesspool truck to discharge the septage into the treatment facility as per the design considerations. In case the no. of cesspool trucks/overall septage load increases in future, the extra cesspool trucks will be diverted to other STPs of Dehradun city.
- Uttarakhand Jal Sansthan (South Division) Dehradun shall provide the available land within STP premises to build co-treatment facility in the Kargi Chowk 68 MLD STP.
- The treatment facility design will be limited to the land availability and in respect of total septage load currently received at the STP.
- Design considerations will be prepared based on the data provided by UJS (South division), Dehradun and will be shared with the concerned officials of Jal Sansthan; an excel sheet is attached in the mail for reference.
- Jal Sansthan will provide all the data required for preparing the said document.
- Based upon the design recommendations for septage co-treatment of NIUA, DPR shall be prepared by Uttarakhand Jal Sansthan (UJS) (South Division) Dehradun and request for funds will be raised to the Uttarakhand Government as per the requirements.

The meeting was concluded with agreement on above mentioned points.

  
 (Maneesh Semwal)  
 Executive Engineer (South)  
 Uttarakhand Jal Sansthan  
 Dehradun

**Copy to:-**

1. Chief General Manager, Uttarakhand Jal Sansthan, Jal Bhawan, Dehradun.
2. General Manager, Uttarakhand Jal Sansthan, Jal Bhawan, Dehradun.
3. Depinder Singh Kapur, Team Lead, National Institute of Urban Affairs, New Delhi.
4. Shri Doab Singh, Programme Officer, NIUA.

  
 Executive Engineer (South)

## 7.5 Design considerations: To check compatibility for discharging FSS

Table 13: Compatibility study for co-treatment

		Formula used for calculation (=)	Value / calculation	Designed limit	OK/Not Ok
Sewage (Se)	Flow (MLD)		14		
	BOD (mg/l)		250		
	COD (mg/l)		450		
	TSS (mg/l)		500		
Faecal Sludge (FS)	Flow (KLD)		130		
	BOD (mg/l)		20,000		
	COD (mg/l)		45,000		
	TS (mg/l)		35,000		
	TKN		1500		
Total Volume of the reactor	(m <sup>3</sup> )	2 reactors * volume of one reactor	19220		
Combined load (in KG)	BOD	$(\text{Se flow} \times \text{Se BOD}) + (\text{FS Flow} \times \text{FS BOD}) / 1000$	6100		
	COD	$(\text{Se flow} \times \text{Se COD}) + (\text{FS Flow} \times \text{FS COD}) / 1000$	12150		
	TSS	$(\text{Se flow} \times \text{Se TSS}) + (\text{FS Flow} \times \text{FS TSS}) / 1000$	11550		
Compliance check	BOD Loading rate kg/m <sup>3</sup>	BOD loading (kg)/Total Volume of reactor (m <sup>3</sup> )	0.56	1.6	ok
	HRT (hrs)	Total Volume of reactor (m <sup>3</sup> ) / (Sewage flow + Sludge flow)	1.36	3 hrs	ok

Complete calculation for compatibility study and design of facility can be accessed through link given below <https://drive.google.com/file/d/1K4Ej9cmaZxyrugI0FeCvJG8jk9F0cpqA/view?usp=sharing>







Download our latest reports, research briefs  
and training modules at:

[scbp.niua.org](http://scbp.niua.org)

#### **About NIUA**

NIUA is a premier national institute for research, capacity building and dissemination of knowledge in the urban sector, including sanitation. Established in 1976, it is the apex research body for the Ministry of Housing and Urban Affairs (MoHUA), Government of India. NIUA is also the strategic partner of the MoHUA in capacity building for providing single window services to the MoHUA/states/ULBs. The Institute includes amongst its present and former clients Housing and Urban Development Corporation, Niti Ayog, City and Industrial Development Corporation of Maharashtra, USAID, World Bank, Asian Development Bank, GIZ, UNICEF, UNEP, UNOPS, Cities Alliance, Bill & Melinda Gates Foundation, Rockefeller Foundation, Global Green Growth

#### **About SCBP**

Sanitation Capacity Building Platform (SCBP) is an initiative of the National Institute of Urban Affairs (NIUA) for addressing urban sanitation challenges in India. The 3 year programme (starting 2016) is supported by a Gates Foundation grant. It is aimed at promoting decentralised urban sanitation solutions for septage and waste water management. The Platform is an organic and growing collaboration of universities, training centres, resource centres, non-governmental organizations, consultants and experts. The Platform currently has on board CEPT University, CDD Society and BORDA, ASCI, AILSG, UMC, ESF, CSE, WaterAid, CPR, iDECK, CSTEP and WASHi. The Platform works in close collaboration with the National Faecal Sludge and Septage Management Alliance (NFSSMA).



National Institute of Urban Affairs

### **National Institute of Urban Affairs**

1<sup>st</sup> Floor, Core 4B, India Habitat Centre, Lodhi Road, New Delhi - 110003  
Phone: 011-24617517, 24617543, 24617595, Fax: 011-24617513  
E-mail: [niua@niua.org](mailto:niua@niua.org) • Website: [www.niua.org](http://www.niua.org), [scbp.niua.org](http://scbp.niua.org)